



MAXIVAREM

**SOLLEVAMENTO ACQUA - ACQUA CALDA
WATER BOOSTER SYSTEMS - DOMESTIC HOT WATER**

Modello/Model: S3 750 461

Caratteristiche tecniche - technical features



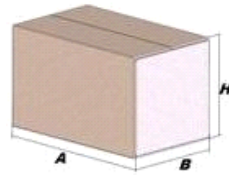

Volume Volume		750 L
raccordo connector		1" 1/2 GAS (ISO 228)
temperatura esercizio working temperature	TS	-10 +99 °C
pressione max. Max pressure	PS	10 bar
pressione prova test pressure	PT	15 bar
precarica precharged pressure		2 bar
Fluido Fluid		Aria+acqua Air+water
Ente notificato per certificazione PED Notified Body number:		/
Modulo: Module:		/
N° certificato N° certificate:		/

Imballo - packaging

	A	B	H
dimensioni (mm) dimensions (mm)			
volume (m ³) volume (m ³)		0,00	
peso (kg) weight (kg)		148,3	
q.ta per cartone q.ty for box		1	
quantità per paletta Q,y for std. pallet		1	



Parti di ricambio - Spare parts

	codice item	materiale material	potabilità potable	trattamento treatment	immagine image
Membrana Membrane	V421000	GOMMA PER ACQUA USO ALIMENTARE / RUBBER FOR POTABLE WATER	x		
Controflangia Coverflange	V50500	ACCIAIO AL CARBONIO / CARBON STEEL		VERNICIATURA / PAINTED	
Attacco superiore Top flange	V50305	ACCIAIO AL CARBONIO / CARBON STEEL		ZINCATURA / GALVANIZED	
Dado 1/2 + guarnizione 1/2" nut gasket	V50880	ACCIAIO AL CARBONIO / CARBON STEEL		ZINCATURA / GALVANIZED	
Valvola precarica Precharge valve	V50802	OTTONE / BRASS			

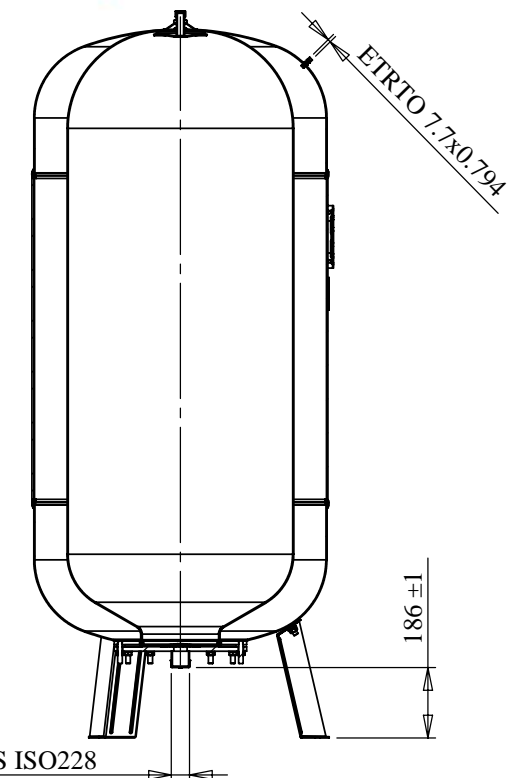
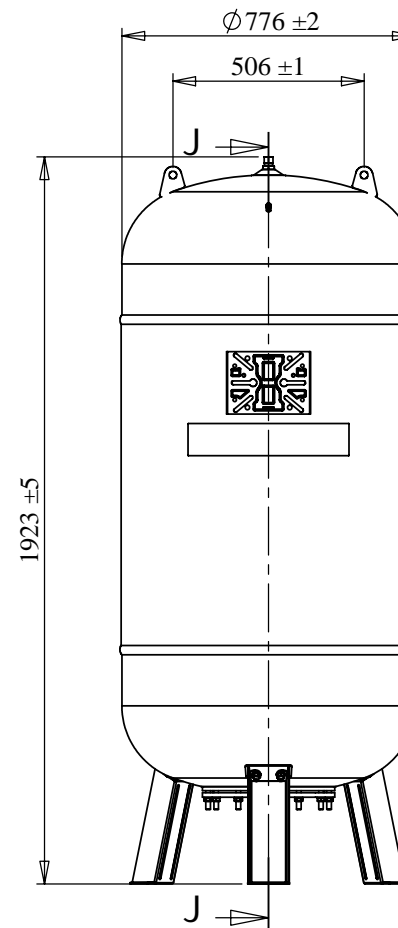
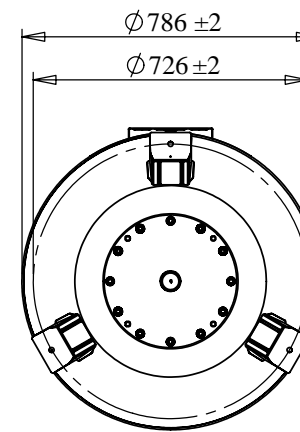

Quote senza indicazione di tolleranza: grado di precisione MEDIO, UNI EN 22768-1		LIPRO 055	TIPO PARTE	COLORE RAL3020
SMUSSI NON QUOTATI	RUGOSITA'	QUANTITA' PER GRUPPO FOGLIO	FORMATO FOGLIO A3	FINITURA SUPERFICIALE
SCALA 1:20		FOGLIO 1 / 3		NOME DATA
GRUPPO VAREM via Sabbioni n° 2 - 35024 Bovolenta - Padova ITALIA e-mail:technical@varem.com		Disegnato F.Mazzucato		06/07/2010
PARTICOLARE MAXIVAREM LS LT.750 B.FVRD		Approvato		
MACCHINA / COMMESSA		CODICE S3750461		INDICE REV. 0

Il presente disegno è di proprietà della **VAREM** e non può essere riprodotto ne comunicato a terzi senza ns autorizzazione scritta